



# The **POWER** of **QUALITY**



**Cuando  
la calidad  
y la innovación  
se unen**



# Gama de Brocas

## Gama



## Materiales

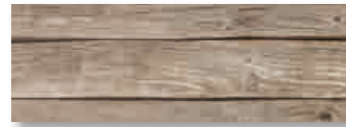

## Aplicaciones



# Gama de Brocas

## Gama



## Materiales





## Aplicaciones



# Índice

## Percusión

SÚPER		10
EXTRA		11
QUATRIUM		12

## Madera

HB		14
PALA		15



## Metal

HSS		16
HSS-Co		17

## SDS

QUATTRIC II		18
POINTER		20
POINTER M		21
MAX II / MAX IV		22
FHD		23
CINCELES FCP		24

## Porcelánico

ULTIMATE		25
D-GT		26
DIAMANTE		27

## Coronas

MULTIMATERIAL		28
METAL		30



## Leyenda

PIEDRA	METAL HSS	SDS
HORMIGÓN	METAL HSS-Co	CRISTAL/ GERÁMICA
MADERA		

# Broca SÚPER D-S

## Percusión

Broca **universal** para perforaciones rotatorias o de impacto en **mampostería y piedra natural**

Punta de carburo reforzada de 130° para una vida útil duradera, resistente a la temperatura

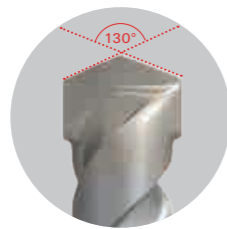

Forjada por rodillo según la norma DIN 8039

Adaptable para perforaciones rotatorias o con percutor

Extracción óptima del polvo gracias a la geometría de su flauta

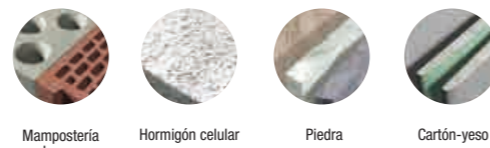

DIN 8039



# Broca EXTRA D-C

## Percusión

Broca para **hormigón** con **punta de carburo**

Punta de carburo de 130° para una vida útil más larga, extremadamente resistente a la temperatura

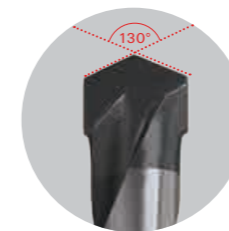

Ofrece robustez y es muy resistente a roturas

Fresada de acuerdo con la norma DIN 8039

Adecuada para perforaciones rotatorias o con percutor

Extracción óptima del polvo gracias a la geometría de su flauta



DIN 8039



# Broca QUATRIUM D-SDX

## Percusión

La mejor broca para **mampostería** con **4 puntas**

Punta de carburo de 130° para asegurar una larga vida útil, muy resistente a la temperatura

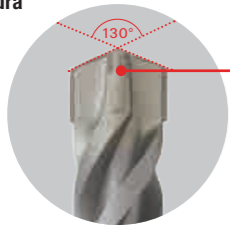

Broca de 4 puntas para mejorar el rendimiento en la perforación

El diseño de la flauta 4x4 minimiza el desgaste y la fricción transmitiendo una baja vibración y facilitando su uso

Punta de centrado que facilita el posicionamiento y previene que se deslice

Las hélices aseguran una extracción óptima del polvo y evitan el calentamiento y desgaste de la broca

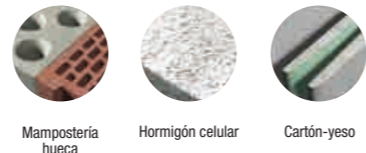

Mampostería hueca    Hormigón celular    Cartón-yeso



130°



**X4**  
PUNTAS

**QUA X TRIUM**

**La broca más evolucionada del mercado**

# Broca HB D-WS

## Madera

### Broca de **madera** con **punta de centrado**



# Broca PALA D-WF

## Madera

### Broca de **madera** con **punta muy afilada**

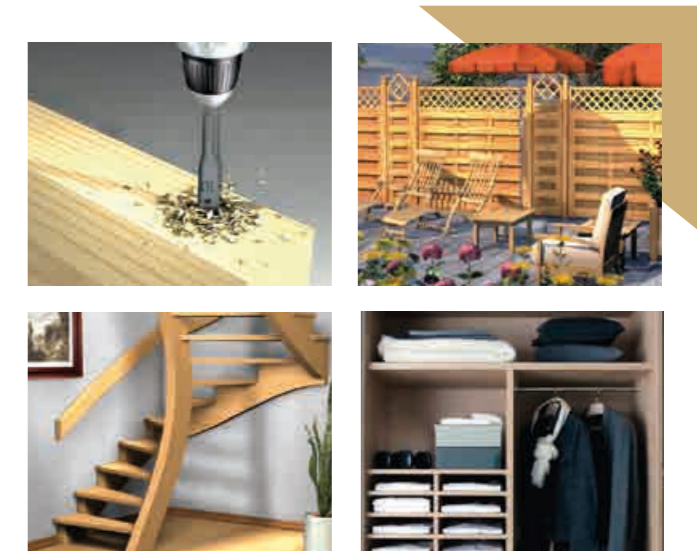
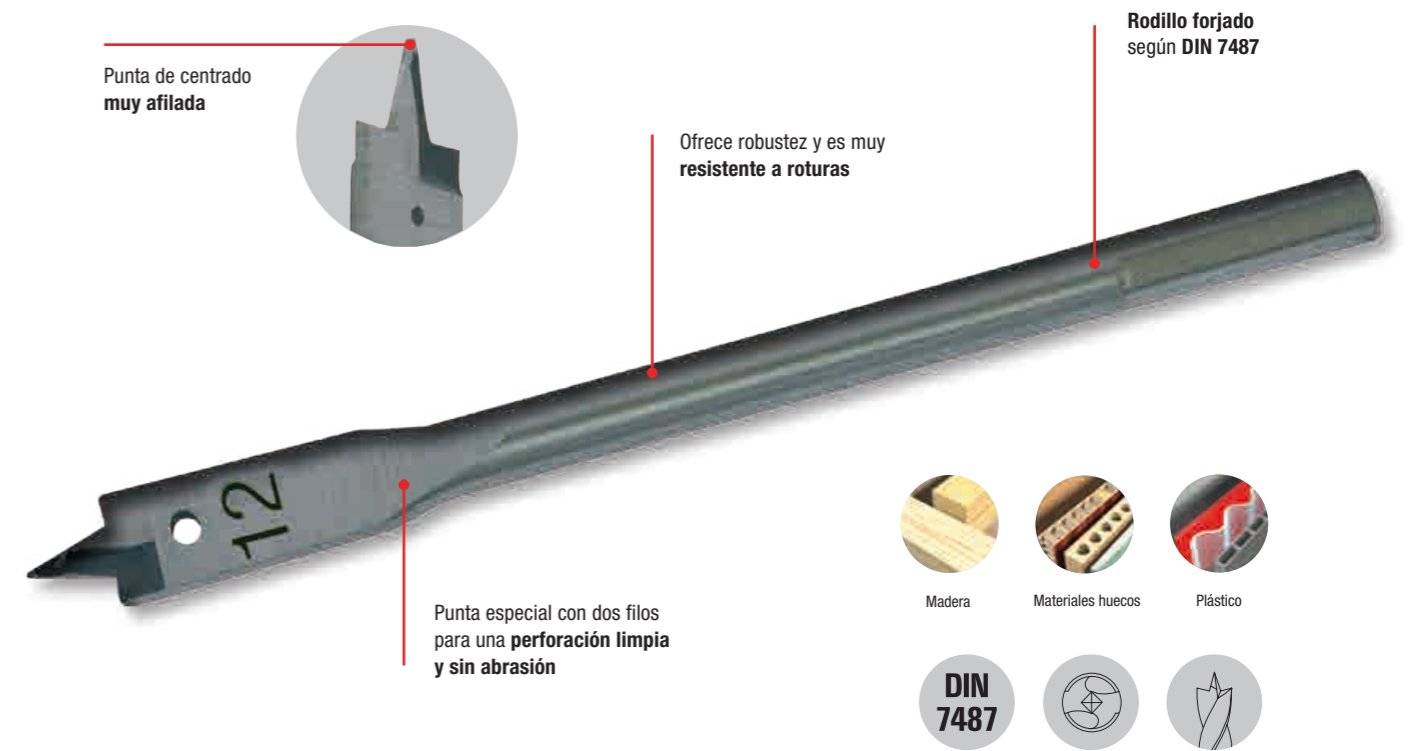



# Broca HSS D-HSS-R Metal

## Broca de metal de alto rendimiento

Ángulo de la punta de 118° para mejorar la refrigeración y la precisión

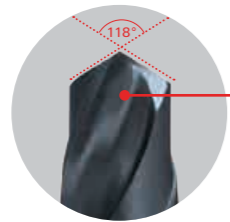

Borde de cincel con refuerzos, insensibles a las fuerzas laterales

Fabricada en acero robusto HSS

Rodillo forjado según DIN 338

Broca robusta con gran resistencia a roturas



Extracción óptima de las virutas gracias a su flauta en forma de N



Metal

Otros metales

DIN 338



118°



# Broca HSS-Co D-HSS-Co Metal

## Broca de metal de alta precisión

Ángulo de 135° para una perforación rápida

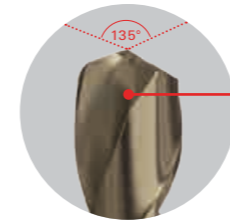

Punta de centrado para aumentar la precisión y reducir el esfuerzo en el avance

Broca robusta con gran resistencia a roturas

Fabricada en acero robusto HSS

Rodillo fresado según DIN 338

Materiales y fabricación de alta calidad para asegurar una mayor vida útil y mejor precisión

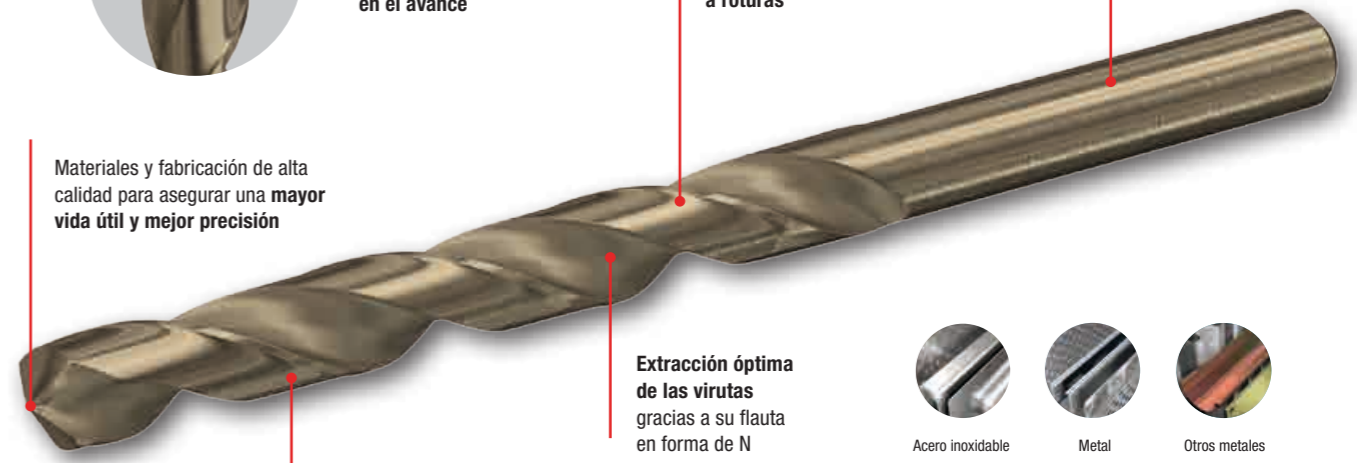

Extracción óptima de las virutas gracias a su flauta en forma de N

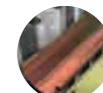

Acero inoxidable

Metal

Otros metales

DIN 338



135°



Gracias a la aleación de cobalto (5% Co) es altamente resistente al calor y adecuada para materiales duros y difíciles



# Broca QUATTRIC II SDS

La broca para **hormigón armado**  
de **alto rendimiento**

La punta de centrado **facilita la colocación**  
y **previene que la broca se deslice**

Las **fases de refuerzo**  
previenen el enganche  
en los armados

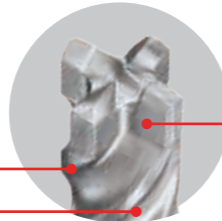

**Indicador de desgaste**  
para detectar fácilmente  
el límite de desgaste  
conforme a PGM

Los **bordes de corte**  
incrementan la velocidad  
de perforación

**Cabeza con diseño  
Power Shoulder,**  
fases de refuerzo  
y marcas de uso

**Núcleo reforzado**  
para mayor duración

Cabeza de metal de  
carburo sólido

**Nuevo multi-espiral**  
diseñado para trabajos duros  
y para ganar velocidad



Hormigón armado    Hormigón    Ladrillo macizo    Ladrillo macizo sílico-calcareo    Piedra

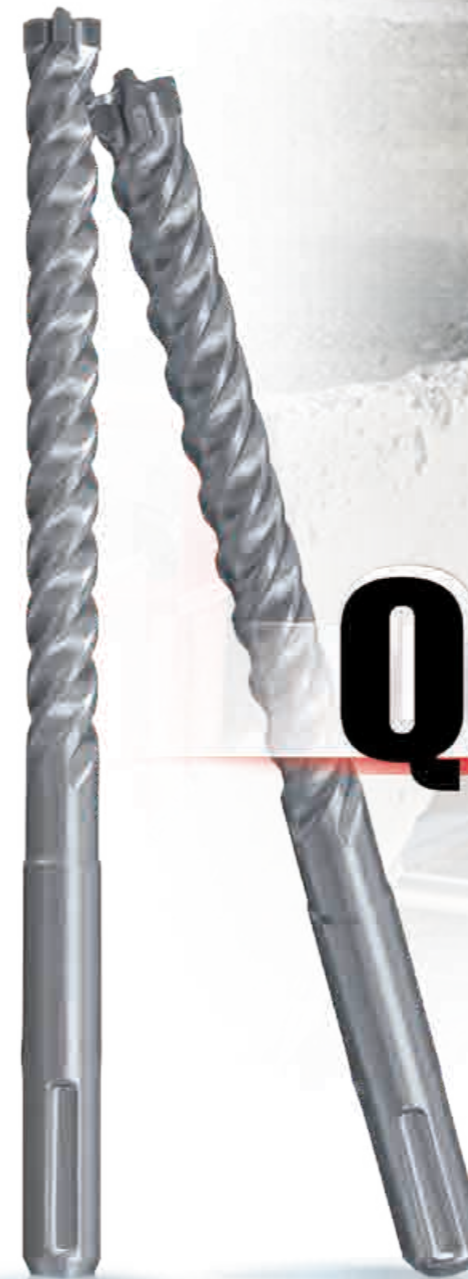

# Quattric II

**Mínimo  
esfuerzo**

**Máxima  
duración**



# Broca POINTER SDS

Estableciendo **nuevos estándares** en **velocidad de perforación**

La punta de centrado **facilita la colocación y previene que la broca se deslice**

Sus fases de refuerzo patentadas **reducen la probabilidad de atasco en los armados**

La tecnología **Power Breakers** crea micro fisuras en el material y aumenta la velocidad de perforado

El espiral de núcleo reforzado ofrece una mayor vida útil

Óptima extracción de polvo **gracias a la geometría de la flauta**

Hormigón Ladrillo macizo Ladrillo macizo sílico-calcareo Piedra

SDS Plus PGM



# Broca POINTER M SDS

La broca perfecta para **mampostería**

Filo de carburo con un ángulo de 130° para asegurar un **mayor vida útil**

El engarce acortado SDS-Plus **reduce el impacto de la broca en el taladro y evita un posible mal uso**

Dos hilos de corte de metal duro para una **perforación rápida y segura**

La punta afilada con diamante asegura un **avance de perforación rápido y seguro en diferentes materiales**

El gran volumen de la flauta garantiza una **eliminación óptima del polvo**

Ladrillo hueco Hormigón celular Ladrillo hueco sílico-calcareo

SHORT PGM



# Broca MAX II / MAX IV SDS

## Las brocas de percusión con **engarce SDS Max**

Certificado PGM asegurando el diámetro de la perforación

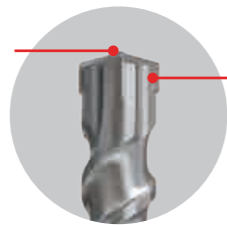

2 puntas en Ø12 y Ø14  
4 puntas en Ø superiores

El engarce SDS Max asegura una **transmisión óptima de fuerza** y permite **perforar rápidamente** agujeros de gran volumen

El cuádruple espiral **transporta el polvo de manera eficiente** fuera de la perforación

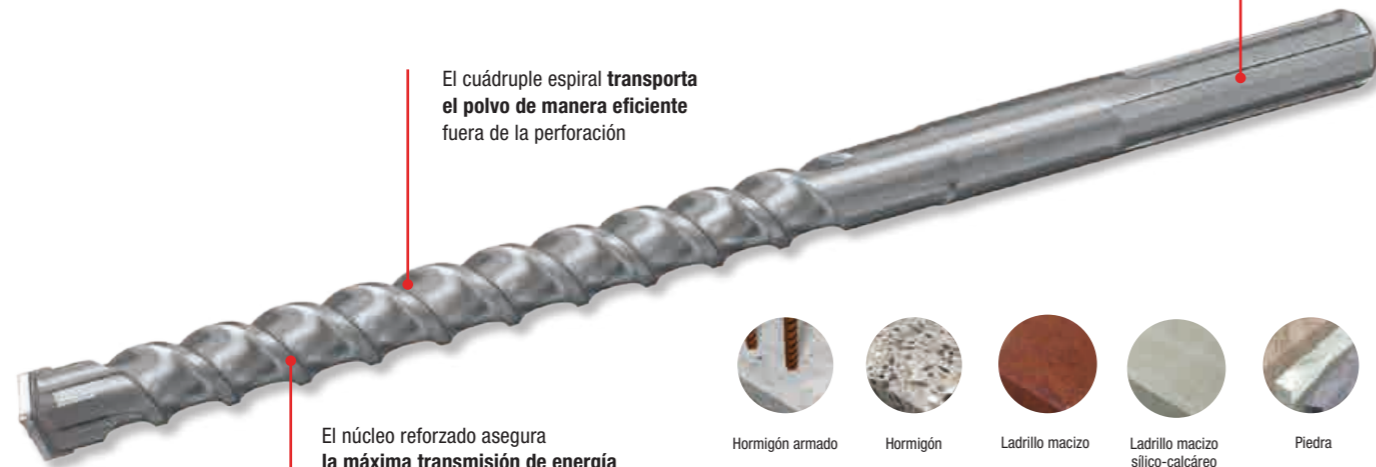

El núcleo reforzado asegura **la máxima transmisión de energía** y la **reducción de la vibración**

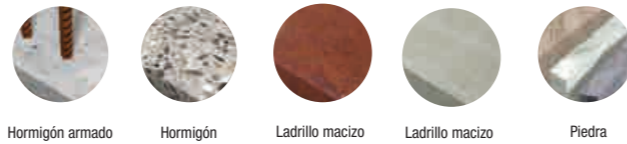

# Broca FHD SDS

## Perforación **sin polvo**. Ideal para ambientes de **trabajo limpios**. Garantía en la aplicación de **anclajes certificados**

Puntas de precisión fabricadas en metal carburo para una **perforación más rápida**

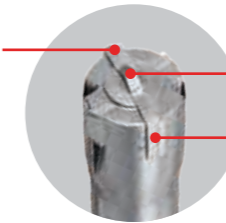

Punta de centrado que permite **posicionar la broca y evitar que se deslice**

Marcas de desgaste para **identificar el desgaste según la certificación PGM**

Disponible para **SDS Plus** y **SDS Max**

Perforación y aspirado del polvo en un único paso, **ahorrando mucho tiempo para la posterior fijación**



**Extracción inmediata del polvo** para una perforación más limpia y sana

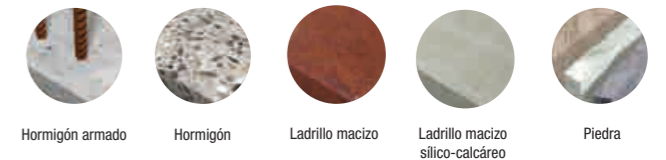

**Aspirador FVC 35**  
para un trabajo impecable

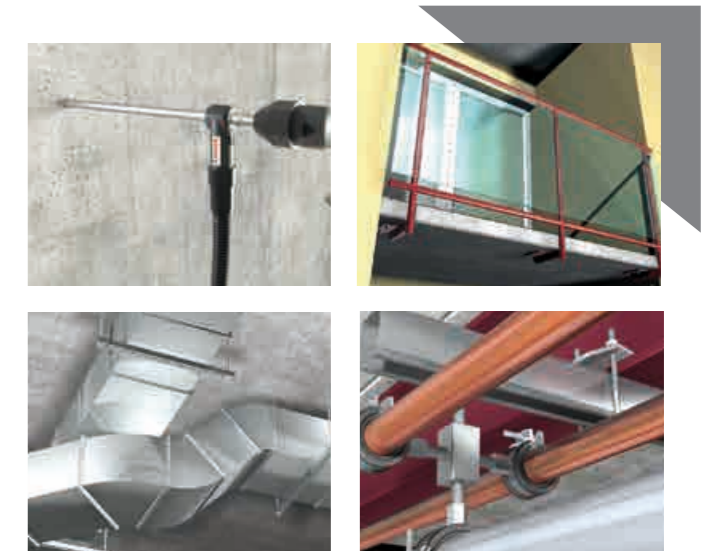

# Cinceles FCP SDS

Cinceles para un **máximo rendimiento** y una **vida útil más larga**



FCP Flat

Con su superficie de trabajo asegura una larga vida útil



FCP Pointed

Su diseño auto afilado garantiza un alto poder de extracción durante toda su vida útil



FCP Spade

Con mayor superficie de corte permite la eliminación de materiales en grandes volúmenes



FCP Max Flat

Con su superficie de trabajo asegura una larga vida útil, engarce SDS Max



FCP Max Pointed

Su diseño auto afilado garantiza un alto poder de extracción durante toda su vida útil, engarce SDS Max



FCP Max Spade

Con mayor superficie de corte permite la eliminación de materiales en grandes volúmenes, engarce SDS Max



Hormigón Mampostería hueca Piedra



SDS Plus SDS Max



# Broca ULTIMATE Porcelánico

Broca universal con **punta de carburo, ideal porcelanato**

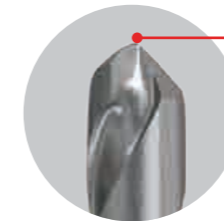

Punta de carburo **extremadamente afilada**, ideal para materiales de construcción variados

La forma especial de la punta de carburo **acelera la perforación**, lo que la hace adecuada para taladros de batería

La soldadura de alta calidad asegura una **resistencia extrema a la temperatura**

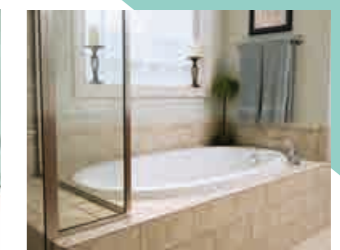
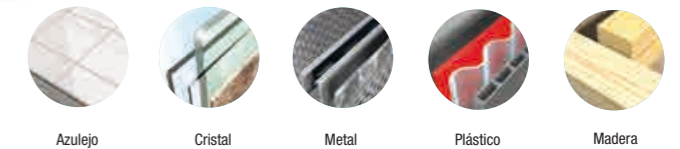
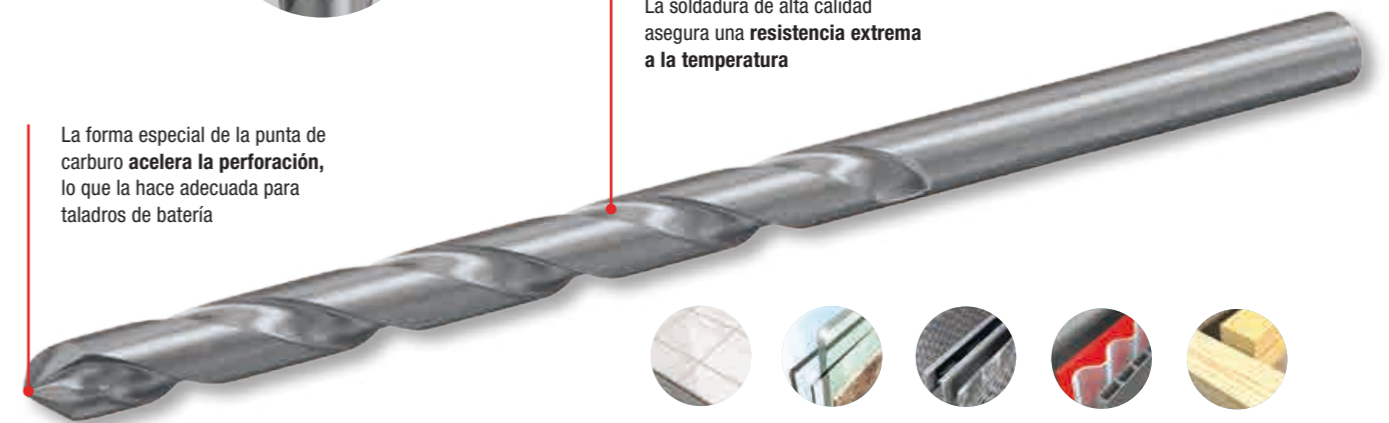

# Broca D-GT

## Porcelánico

### Broca con filo de carburo para **vidrio y azulejos**

La punta con un ángulo de 120° permite **perforar materiales duros**

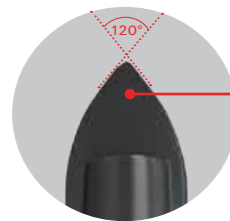

Punta de centrado para **mayor precisión**

Los mejores resultados de perforación se logran a **bajas velocidades** y con suficiente **enfriamiento** con agua, aguarrás, vinagre o petróleo

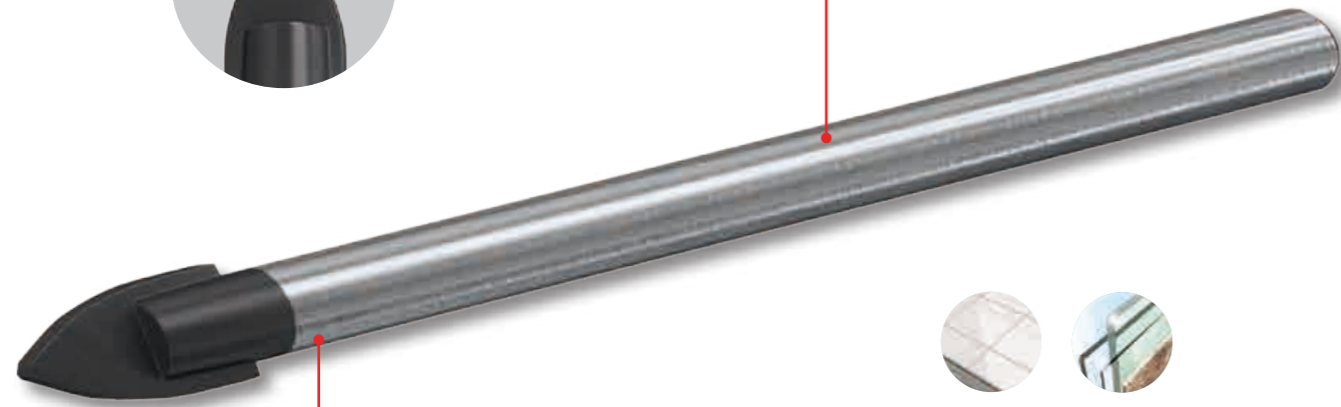

Punta de carburo para una **mayor vida útil y mejor resistencia a la temperatura**



Azulejo



Cristal



120°



H<sub>2</sub>O



# Broca **DIAMANTE** HS-Di

## Porcelánico

### Broca de **diamante autorrefrigerante** para materiales de construcción **extremadamente duros**

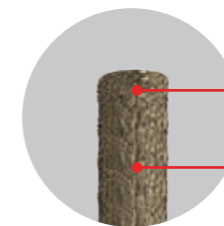

Superficie de corte con punta de diamante para una **perforación precisa en azulejos, cerámicas y gres**

**Baja formación de polvo** debido a la cera de la broca

Engarce hexagonal que asegura **una perfecta sujeción de la broca en la máquina**

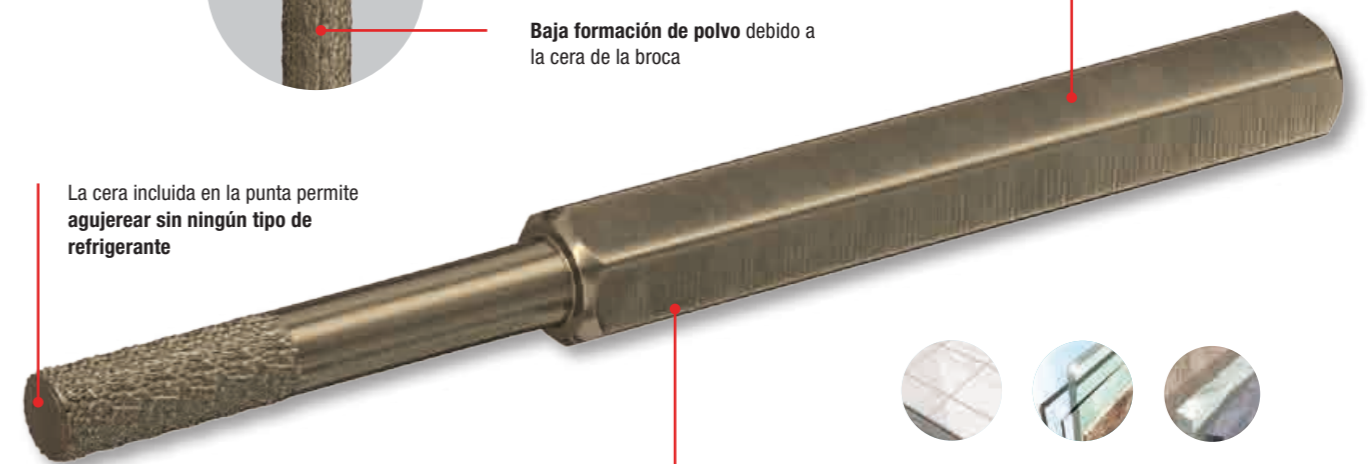

La cera incluida en la punta permite **agujerear sin ningún tipo de refrigerante**

**Mayor vida útil** gracias a la superficie recubierta de níquel



Azulejo



Cristal



Piedra



H<sub>2</sub>O

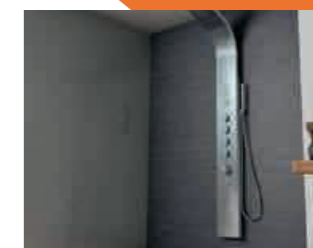
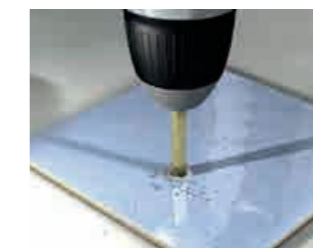

# Corona MULTIMATERIAL HS-Multi

La corona con **filos de carburo** para diferentes **materiales de construcción**

Hilos de carburo para un rápido avance de la perforación y una larga vida útil

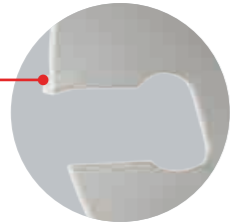

La sierra hundida de alta calidad asegura orificios precisos, limpios y perfectamente redondos



Cabeza adaptada para un cambio rápido de la corona una vez acabado su uso

Punta de carburo para una aplicación universal y larga vida útil



Adaptador con **broca de centrado**

Punta de la broca de 130° para una alta resistencia de la cabeza

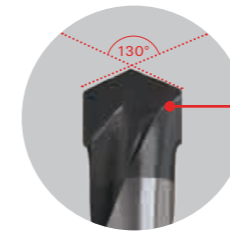

Incluye una broca de centrado de 110 mm y una llave hexagonal

Adaptador con engarce hexagonal que permite el correcto funcionamiento en el taladro

Adaptador equipado con la función "quick change" para un cambio rápido de corona

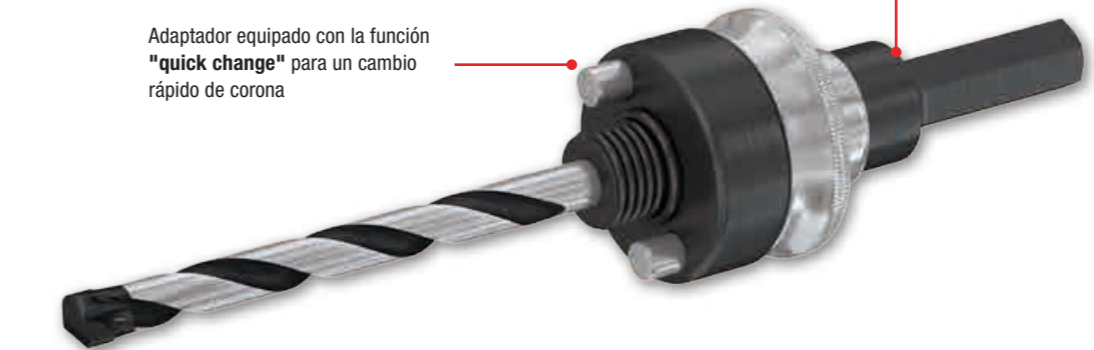

# Corona METAL HSS-Co

## La corona de **aleación de cobalto** para un **acabado impecable**

Alta velocidad de la corona gracias a la optimización de sus dientes

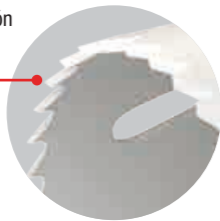

Cuerpo de acero con una aleación especial de carbono para unos agujeros precisos

Ángulo positivo de los dientes para evitar la vibración

Rápido agujereado gracias a la variable cantidad de dientes por pulgada (entre 4-6)

Larga duración gracias su aleación del 8% de cobalto en los dientes de corte



Cabeza adaptada para un cambio rápido de la corona una vez acabado su uso

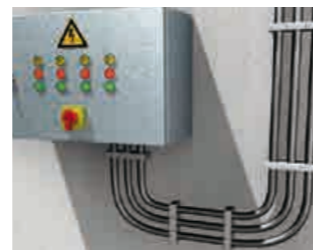

## Adaptador con **broca de centrado**

Punta de la broca de 135° para un rápido progreso del agujereado

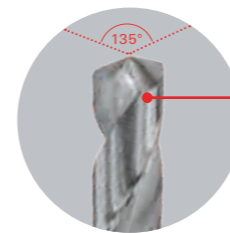

Punta de centrado para una optimización en el centrado

Adaptador con engarce hexagonal que permite el correcto funcionamiento en el taladro

Adaptador equipado con la función "quick change" para un cambio rápido de corona

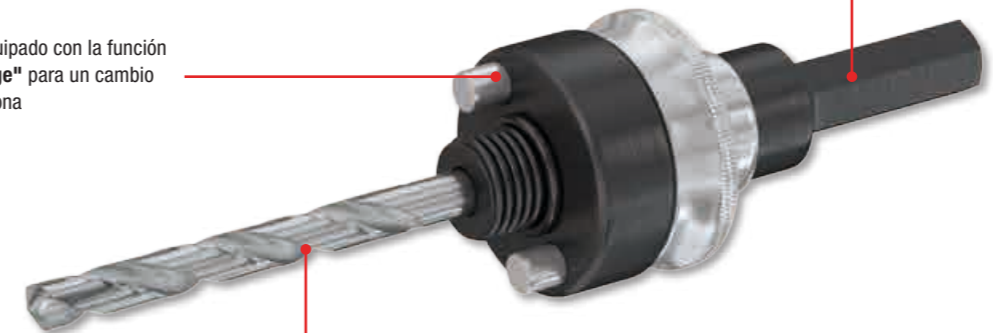

Incluye una broca de centrado de 90mm y una llave hexagonal



Acero inoxidable

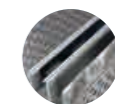

Metal



Madera



Plástico



STAINLESS





## Percusión SÚPER



Tipo	Art. nº	EAN	Familia	Unidad mínima servicio (packs)	Unidades por pack	Packs por embalaje
BROCA S <b>3x60</b>	530522	4048962203585	E32	1	2	60
BROCA S <b>4x75</b>	530523	4048962203592	E32	1	2	60
BROCA S <b>5x85</b>	530524	4048962203608	E32	1	1	60
BROCA S <b>6x100</b>	530527	4048962203622	E32	1	1	60
BROCA S <b>7x100</b>	530552	4048962203790	E32	1	1	60
BROCA S <b>8x120</b>	530553	4048962203806	E32	1	1	30
BROCA S <b>9x120</b>	530556	4048962203837	E32	1	1	30
BROCA S <b>10x120</b>	530557	4048962203844	E32	1	1	30
BROCA S <b>12x150</b>	530563	4048962203882	E32	1	1	30
BROCA S <b>14x150</b>	530566	4048962203912	E32	1	1	30
BROCA S <b>15x150</b>	530568	4048962203936	E32	1	1	30
BROCA S <b>16x150</b>	530569	4048962203943	E32	1	1	30
BROCA S <b>18x160</b>	530571	4048962203967	E32	1	1	18
BROCA S <b>20x160</b>	530573	4048962203981	E32	1	1	18
BROCA BLS <b>5x150</b>	530525	4048962203615	E32	1	1	1
BROCA BLS <b>6x150</b>	530528	4048962203639	E32	1	1	1
BROCA BLS <b>8x200</b>	530554	4048962203813	E32	1	1	1
BROCA BLS <b>8x400</b>	530555	4048962203820	E32	1	1	1
BROCA BLS <b>10x200</b>	530558	4048962203851	E32	1	1	1
BROCA BLS <b>10x400</b>	530559	4048962203868	E32	1	1	1
BROCA BLS <b>12x200</b>	530564	4048962203899	E32	1	1	1
BROCA BLS <b>12x400</b>	530565	4048962203905	E32	1	1	1
BROCA BLS <b>14x400</b>	530567	4048962203929	E32	1	1	1
BROCA BLS <b>16x400</b>	530570	4048962203950	E32	1	1	1
BROCA BLS <b>18x400</b>	530572	4048962203974	E32	1	1	1
BROCA BLS <b>20x400</b>	530574	4048962203998	E32	1	1	18



Tipo	Art. nº	EAN	Familia	Unidad mínima servicio (packs)	Unidades por pack	Packs por embalaje
KIT BROCAS S (5 UDS)	543025	4048962301861	E32	1	1	1
KIT BROCAS S (8 UDS)	543027	4048962301885	E32	1	1	1
KIT BROCAS E (5 UDS)	536606	4048962249293	E32	1	1	1
KIT BROCAS E (8 UDS)	536607	4048962249309	E32	1	1	1

\*KIT 5 BROCAS (Ø4-5-6-8-10) / KIT 8 BROCAS (Ø3-4-5-6-7-8-9-10)

## Percusión EXTRA



Tipo	Art. nº	EAN	Familia	Unidad mínima servicio (packs)	Unidades por pack	Packs por embalaje
BROCA E <b>3x60</b>	530575	4048962204001	E32	1	2	60
BROCA E <b>4x75</b>	530576	4048962204018	E32	1	2	60
BROCA E <b>5x85</b>	530577	4048962204025	E32	1	1	60
BROCA E <b>6x100</b>	530579	4048962204049	E32	1	1	60
BROCA E <b>7x100</b>	530584	4048962204063	E32	1	1	60
BROCA E <b>8x120</b>	530590	4048962204070	E32	1	1	30
BROCA E <b>9x120</b>	530592	4048962204094	E32	1	1	30
BROCA E <b>10x120</b>	530593	4048962204100	E32	1	1	30
BROCA E <b>11x150</b>	530596	4048962204124	E32	1	1	30
BROCA E <b>12x150</b>	530597	4048962204131	E32	1	1	30
BROCA E <b>14x150</b>	530601	4048962204155	E32	1	1	30
BROCA E <b>16x150</b>	530604	4048962204162	E32	1	1	30
BROCA E <b>20x160</b>	530607	4048962204186	E32	1	1	18
BROCA BLE <b>6x400</b>	530580	4048962204056	E32	1	1	1
BROCA BLE <b>8x400</b>	530591	4048962204087	E32	1	1	1
BROCA BLE <b>10x400</b>	530595	4048962204117	E32	1	1	1
BROCA BLE <b>12x400</b>	530600	4048962204148	E32	1	1	1

## Percusión QUATRIUM



Tipo	Art. nº	EAN	Familia	Unidad mínima servicio (packs)	Unidades por pack	Packs por embalaje
BROCA D-SDX <b>5,0x44/85</b>	545049	4048962320176	E32	1	1	60
BROCA D-SDX <b>6,0x60/100</b>	545051	4048962320183	E32	1	1	60
BROCA D-SDX <b>8,0x70/120</b>	545052	4048962320190	E32	1	1	30
BROCA D-SDX <b>10,0x70/120</b>	545053	4048962320206	E32	1	1	30
BROCA D-SDX <b>12,0x90/150</b>	545054	4048962320213	E32	1	1	30

# Surtido

## Madera

HB



Tipo	Art. nº	EAN	Familia	Unidad mínima servicio (packs)	Unidades por pack	Packs por embalaje
BROCA HB <b>3</b>	530630	4048962204360	E34	1	2	60
BROCA HB <b>4</b>	530634	4048962204377	E34	1	2	60
BROCA HB <b>5</b>	530635	4048962204384	E34	1	1	60
BROCA HB <b>6</b>	530636	4048962204391	E34	1	1	60
BROCA HB <b>8</b>	530638	4048962204407	E34	1	1	30
BROCA HB <b>10</b>	530639	4048962204414	E34	1	1	30
BROCA HB <b>12</b>	530640	4048962204421	E34	1	1	30

## Madera

PALA



Tipo	Art. nº	EAN	Familia	Unidad mínima servicio (packs)	Unidades por pack	Packs por embalaje
BROCA PALA MADERA <b>12MM</b>	530647	4048962204438	E34	1	1	30
BROCA PALA MADERA <b>14MM</b>	530650	4048962204445	E34	1	1	30
BROCA PALA MADERA <b>16MM</b>	530655	4048962204469	E34	1	1	30
BROCA PALA MADERA <b>18MM</b>	530656	4048962204476	E34	1	1	30
BROCA PALA MADERA <b>20MM</b>	530657	4048962204483	E34	1	1	30
BROCA PALA MADERA <b>22MM</b>	530658	4048962204490	E34	1	1	30
BROCA PALA MADERA <b>24MM</b>	530659	4048962204506	E34	1	1	30
BROCA PALA MADERA <b>25MM</b>	530660	4048962204513	E34	1	1	30
BROCA PALA MADERA <b>26MM</b>	530661	4048962204520	E34	1	1	30
BROCA PALA MADERA <b>28MM</b>	530663	4048962204544	E34	1	1	30
BROCA PALA MADERA <b>30MM</b>	530665	4048962204551	E34	1	1	30

## Metal

HSS



Tipo	Art. nº	EAN	Familia	Unidad mínima servicio (packs)	Unidades por pack	Packs por embalaje
BROCA HSS-R DIN338 <b>1x12/34</b>	530403	4048962202816	E37	1	2	60
BROCA HSS-R DIN338 <b>1,5x18/40</b>	530404	4048962202823	E37	1	2	60
BROCA HSS-R DIN338 <b>2x24/49</b>	530405	4048962202830	E37	1	2	60
BROCA HSS-R DIN338 <b>2,5x30/57</b>	530406	4048962202847	E37	1	2	60
BROCA HSS-R DIN338 <b>3x33/61</b>	530407	4048962202854	E37	1	2	60
BROCA HSS-R DIN338 <b>3,2x36/65</b>	530408	4048962202861	E37	1	2	60
BROCA HSS-R DIN338 <b>3,5x39/70</b>	530409	4048962202878	E37	1	2	60
BROCA HSS-R DIN338 <b>4x43/75</b>	530410	4048962202885	E37	1	2	60
BROCA HSS-R DIN338 <b>4,2x43/75</b>	530411	4048962202892	E37	1	1	60
BROCA HSS-R DIN338 <b>4,5x47/80</b>	530412	4048962202908	E37	1	1	60
BROCA HSS-R DIN338 <b>5x52/86</b>	530413	4048962202915	E37	1	1	60
BROCA HSS-R DIN338 <b>5,5x57/93</b>	530415	4048962202939	E37	1	1	60
BROCA HSS-R DIN338 <b>6x57/93</b>	530416	4048962202946	E37	1	1	60
BROCA HSS-R DIN338 <b>6,5x63/101</b>	530417	4048962202953	E37	1	1	60
BROCA HSS-R DIN338 <b>7x69/109</b>	530418	4048962202960	E37	1	1	30
BROCA HSS-R DIN338 <b>8x75/117</b>	530483	4048962203233	E37	1	1	30
BROCA HSS-R DIN338 <b>8,5x75/117</b>	530484	4048962203240	E37	1	1	30
BROCA HSS-R DIN338 <b>9x81/125</b>	530485	4048962203257	E37	1	1	30
BROCA HSS-R DIN338 <b>10x87/133</b>	530487	4048962203271	E37	1	1	30
BROCA HSS-R DIN338 <b>11x94/142</b>	530488	4048962203288	E37	1	1	30
BROCA HSS-R DIN338 <b>12x101/151</b>	530489	4048962203295	E37	1	1	30
BROCA HSS-R DIN338 <b>13x101/151</b>	530490	4048962203301	E37	1	1	30
BROCA HSS-R DIN338 <b>2,0x24/49</b>	543083	4048962302387	E37	1	1	10
BROCA HSS-R DIN338 <b>2,5x30/57</b>	543088	4048962302431	E37	1	1	10
BROCA HSS-R DIN338 <b>3,0x33/61</b>	543093	4048962302486	E37	1	1	10
BROCA HSS-R DIN338 <b>3,5x39/70</b>	543098	4048962302530	E37	1	1	10
BROCA HSS-R DIN338 <b>4,0x43/75</b>	543103	4048962302585	E37	1	1	10
BROCA HSS-R DIN338 <b>4,5x47/80</b>	543108	4048962302639	E37	1	1	10
BROCA HSS-R DIN338 <b>5,0x52/86</b>	543113	4048962302684	E37	1	1	10
BROCA HSS-R DIN338 <b>6,0x57/93</b>	543123	4048962302783	E37	1	1	10
BROCA HSS-R DIN338 <b>7,0x69/109</b>	543133	4048962302882	E37	1	1	10
BROCA HSS-R DIN338 <b>8,0x75/117</b>	543143	4048962302981	E37	1	1	5



# Surtido

## Metal

HSS-Co



Tipo	Art. n°	EAN	Familia	Unidad mínima servicio (packs)	Unidades por pack	Packs por embalaje
BROCA HSS-Co DIN338 <b>1x12/34</b>	530491	4048962203318	E37	1	2	60
BROCA HSS-Co DIN338 <b>1,5x18/40</b>	530492	4048962203325	E37	1	2	60
BROCA HSS-Co DIN338 <b>2x24/49</b>	530493	4048962203332	E37	1	2	60
BROCA HSS-Co DIN338 <b>2,5x30/57</b>	530494	4048962203349	E37	1	2	60
BROCA HSS-Co DIN338 <b>3x33/61</b>	530495	4048962203356	E37	1	2	60
BROCA HSS-Co DIN338 <b>3,2x36/65</b>	530496	4048962203363	E37	1	2	60
BROCA HSS-Co DIN338 <b>3,5x39/70</b>	530497	4048962203370	E37	1	2	60
BROCA HSS-Co DIN338 <b>4x43/75</b>	530498	4048962203387	E37	1	2	60
BROCA HSS-Co DIN338 <b>4,2x43/75</b>	530499	4048962203394	E37	1	1	60
BROCA HSS-Co DIN338 <b>4,5x47/80</b>	530504	4048962203400	E37	1	1	60
BROCA HSS-Co DIN338 <b>5x52/86</b>	530505	4048962203417	E37	1	1	60
BROCA HSS-Co DIN338 <b>5,5x57/93</b>	530506	4048962203424	E37	1	1	60
BROCA HSS-Co DIN338 <b>6x57/93</b>	530507	4048962203431	E37	1	1	60
BROCA HSS-Co DIN338 <b>6,5x63/101</b>	530508	4048962203448	E37	1	1	60
BROCA HSS-Co DIN338 <b>7x69/109</b>	530509	4048962203455	E37	1	1	30
BROCA HSS-Co DIN338 <b>7,5x69/109</b>	530510	4048962203462	E37	1	1	30
BROCA HSS-Co DIN338 <b>8x75/117</b>	530511	4048962203479	E37	1	1	30
BROCA HSS-Co DIN338 <b>8,5x75/117</b>	530512	4048962203486	E37	1	1	30
BROCA HSS-Co DIN338 <b>9x81/125</b>	530513	4048962203493	E37	1	1	30
BROCA HSS-Co DIN338 <b>10x87/133</b>	530515	4048962203516	E37	1	1	30
BROCA HSS-Co DIN338 <b>11x94/142</b>	530517	4048962203530	E37	1	1	30
BROCA HSS-Co DIN338 <b>12x101/151</b>	530519	4048962203554	E37	1	1	30
BROCA HSS-Co DIN338 <b>13x101/151</b>	530521	4048962203578	E37	1	1	30
BROCA HSS-Co DIN338 <b>1,5x18/40</b>	543185	4048962303407	E37	1	1	10
BROCA HSS-Co DIN338 <b>2,0x24/49</b>	543190	4048962303452	E37	1	1	10
BROCA HSS-Co DIN338 <b>2,5x30/57</b>	543195	4048962303506	E37	1	1	10
BROCA HSS-Co DIN338 <b>3,0x33/61</b>	543200	4048962303551	E37	1	1	10
BROCA HSS-Co DIN338 <b>3,2x36/65</b>	543202	4048962303575	E37	1	1	10
BROCA HSS-Co DIN338 <b>3,5x39/70</b>	543205	4048962303605	E37	1	1	10
BROCA HSS-Co DIN338 <b>4,0x43/75</b>	543210	4048962303650	E37	1	1	10
BROCA HSS-Co DIN338 <b>4,2x43/75</b>	543212	4048962303674	E37	1	1	10
BROCA HSS-Co DIN338 <b>4,5x47/80</b>	543215	4048962303704	E37	1	1	10
BROCA HSS-Co DIN338 <b>5,0x52/86</b>	543220	4048962303759	E37	1	1	10
BROCA HSS-Co DIN338 <b>5,5x57/93</b>	543225	4048962303803	E37	1	1	10
BROCA HSS-Co DIN338 <b>6,0x57/93</b>	543230	4048962303858	E37	1	1	10
BROCA HSS-Co DIN338 <b>6,5x63/101</b>	543235	4048962303902	E37	1	1	10
BROCA HSS-Co DIN338 <b>7,0x69/109</b>	543240	4048962303957	E37	1	1	10
BROCA HSS-Co DIN338 <b>8,0x75/117</b>	543250	4048962304053	E37	1	1	5
BROCA HSS-Co DIN338 <b>8,5x75/117</b>	543255	4048962304107	E37	1	1	5
BROCA HSS-Co DIN338 <b>9,0x81/125</b>	543260	4048962304152	E37	1	1	5
BROCA HSS-Co DIN338 <b>9,5x81/125</b>	543265	4048962304206	E37	1	1	5
BROCA HSS-Co DIN338 <b>10,0x87/133</b>	543270	4048962304251	E37	1	1	5
BROCA HSS-Co DIN338 <b>10,5x94/142</b>	543272	4048962304275	E37	1	1	5
BROCA HSS-Co DIN338 <b>11,0x94/142</b>	543273	4048962304282	E37	1	1	5
BROCA HSS-Co DIN338 <b>12,0x101/151</b>	543275	4048962304305	E37	1	1	5
BROCA HSS-Co DIN338 <b>13,0x101/151</b>	543277	4048962304329	E37	1	1	5



## SDS

QUATTRIC II



Tipo	Art. n°	EAN	Familia	Unidad mínima servicio (packs)	Unidades por pack	Packs por embalaje
SDS Plus QUATTRIC II <b>5/50/115</b>	549973	4048962307092	E33	1	1	5
SDS Plus QUATTRIC II <b>5/100/165</b>	549974	4048962307108	E33	1	1	5
SDS Plus QUATTRIC II <b>6/50/115</b>	549983	4048962307191	E33	1	1	5
SDS Plus QUATTRIC II <b>6/100/165</b>	549979	4048962307153	E33	1	1	5
SDS Plus QUATTRIC II <b>6/150/215</b>	549980	4048962307160	E33	1	1	5
SDS Plus QUATTRIC II <b>6/50/115</b>	549981	4048962307177	E33	1	1	5
SDS Plus QUATTRIC II <b>6,5/150/215</b>	549976	4048962307122	E33	1	1	5
SDS Plus QUATTRIC II <b>7/100/165</b>	549987	4048962307238	E33	1	1	5
SDS Plus QUATTRIC II <b>8/50/115</b>	549993	4048962307290	E33	1	1	5
SDS Plus QUATTRIC II <b>8/100/165</b>	549988	4048962307245	E33	1	1	5
SDS Plus QUATTRIC II <b>8/150/215</b>	549990	4048962307269	E33	1	1	5
SDS Plus QUATTRIC II <b>8/150/215</b>	549991	4048962307276	E33	1	1	5
SDS Plus QUATTRIC II <b>8/250/315</b>	549992	4048962307283	E33	1	1	5
SDS Plus QUATTRIC II <b>10/50/115</b>	549928	4048962306651	E33	1	1	5
SDS Plus QUATTRIC II <b>10/100/165</b>	549922	4048962306590	E33	1	1	5
SDS Plus QUATTRIC II <b>10/100/165</b>	549923	4048962306606	E33	1	1	5
SDS Plus QUATTRIC II <b>10/100/165</b>	549924	4048962306613	E33	1	1	5
SDS Plus QUATTRIC II <b>10/150/215</b>	549925	4048962306620	E33	1	1	5
SDS Plus QUATTRIC II <b>10/150/215</b>	549926	4048962306637	E33	1	1	5
SDS Plus QUATTRIC II <b>10/250/315</b>	549927	4048962306644	E33	1	1	5
SDS Plus QUATTRIC II <b>12/100/160</b>	549932	4048962306699	E33	1	1	5
SDS Plus QUATTRIC II <b>12/110/160</b>	549933	4048962306705	E33	1	1	5
SDS Plus QUATTRIC II <b>12/160/210</b>	549936	4048962306736	E33	1	1	5
SDS Plus QUATTRIC II <b>12/160/210</b>	549937	4048962306743	E33	1	1	5
SDS Plus QUATTRIC II <b>12/210/260</b>	549938	4048962306750	E33	1	1	5
SDS Plus QUATTRIC II <b>12/260/310</b>	549939	4048962306767	E33	1	1	5
SDS Plus QUATTRIC II <b>14/100/160</b>	549941	4048962306781	E33	1	1	5
SDS Plus QUATTRIC II <b>14/160/210</b>	549944	4048962306811	E33	1	1	5
SDS Plus QUATTRIC II <b>14/260/310</b>	549945	4048962306828	E33	1	1	5
SDS Plus QUATTRIC II <b>14/400/450</b>	549943	4048962306804	E33	1	1	5
SDS Plus QUATTRIC II <b>15/160/210</b>	549947	4042205355314	E33	1	1	5
SDS Plus QUATTRIC II <b>16/110/160</b>	549950	4048962306866	E33	1	1	5
SDS Plus QUATTRIC II <b>16/160/210</b>	549951	4048962306873	E33	1	1	5
SDS Plus QUATTRIC II <b>16/260/310</b>	549953	4048962306897	E33	1	1	5
SDS Plus QUATTRIC II <b>18/200/250</b>	549956	4048962306927	E33	1	1	5
SDS Plus QUATTRIC II <b>18/400/450</b>	549957	4048962306934	E33	1	1	5
SDS Plus QUATTRIC II <b>20/400/450</b>	549959	4048962306958	E33	1	1	5
SDS Plus QUATTRIC II <b>22/400/450</b>	549961	4048962306972	E33	1	1	5
SDS Plus QUATTRIC II <b>24/400/450</b>	549963	4048962306996	E33	1	1	5
SDS Plus QUATTRIC II <b>25/400/450</b>	549965	4048962307016	E33	1	1	5
SDS Plus QUATTRIC II <b>28/400/450</b>	549967	4048962307030	E33	1	1	5
SDS Plus QUATTRIC II <b>30/400/450</b>	549969	4048962307054	E33	1	1	5
SDS Plus QUATTRIC II <b>32/400/450</b>	549970	4048962307061	E33	1	1	5

# Surtido

## SDS POINTER



Tipo	Art. nº	EAN	Familia	Unidad mínima servicio (packs)	Unidades por pack	Packs por embalaje
SDS Plus II V POINTER <b>4/50/110</b>	531753	4048962211757	E33	1	1	5
SDS Plus II V POINTER <b>5/50/110</b>	531755	4048962211771	E33	1	1	5
SDS Plus II V POINTER <b>5/100/160</b>	531756	4048962211788	E33	1	1	5
SDS Plus II V POINTER <b>5/150/210</b>	531757	4048962211795	E33	1	1	5
SDS Plus II V POINTER <b>6/50/110</b>	531762	4048962211849	E33	1	1	5
SDS Plus II V POINTER <b>6/100/160</b>	531765	4048962211870	E33	1	1	5
SDS Plus II V POINTER <b>6/150/210</b>	531766	4048962211887	E33	1	1	5
SDS Plus II V POINTER <b>6/200/260</b>	531767	4048962211894	E33	1	1	5
SDS Plus II V POINTER <b>6/200/260</b>	531768	4048962211900	E33	1	1	5
SDS Plus II V POINTER <b>6,5/200/260</b>	531773	4042205306804	E33	1	1	5
SDS Plus II V POINTER <b>7/150/210</b>	531777	4048962211993	E33	1	1	5
SDS Plus II V POINTER <b>8/50/110</b>	531779	4048962212013	E33	1	1	5
SDS Plus II V POINTER <b>8/100/160</b>	531780	4048962212020	E33	1	1	5
SDS Plus II V POINTER <b>8/150/210</b>	531781	4048962212037	E33	1	1	5
SDS Plus II V POINTER <b>8/200/260</b>	531782	4048962212044	E33	1	1	5
SDS Plus II V POINTER <b>8/400/460</b>	531785	4048962212075	E33	1	1	5
SDS Plus II V POINTER <b>9/150/210</b>	531789	4048962212112	E33	1	1	5
SDS Plus II V POINTER <b>10/50/110</b>	531791	4048962212136	E33	1	1	5
SDS Plus II V POINTER <b>10/100/160</b>	531792	4048962212143	E33	1	1	5
SDS Plus II V POINTER <b>10/150/210</b>	531793	4048962212150	E33	1	1	5
SDS Plus II V POINTER <b>10/200/260</b>	531794	4048962212167	E33	1	1	5
SDS Plus II V POINTER <b>10/250/310</b>	531795	4048962212174	E33	1	1	5
SDS Plus II V POINTER <b>10/400/450</b>	531797	4048962212198	E33	1	1	5
SDS Plus II V POINTER <b>11/250/310</b>	531802	4048962212242	E33	1	1	5
SDS Plus II V POINTER <b>12/100/160</b>	531803	4048962212259	E33	1	1	5
SDS Plus II V POINTER <b>12/150/210</b>	531804	4048962212266	E33	1	1	5
SDS Plus II V POINTER <b>12/200/260</b>	531805	4048962212273	E33	1	1	5
SDS Plus II V POINTER <b>12/400/450</b>	531808	4048962212303	E33	1	1	5
SDS Plus II V POINTER <b>13/210/260</b>	531813	4048962212358	E33	1	1	5
SDS Plus II V POINTER <b>14/100/160</b>	531815	4048962212372	E33	1	1	5
SDS Plus II V POINTER <b>14/150/210</b>	531816	4048962212389	E33	1	1	5
SDS Plus II V POINTER <b>14/200/260</b>	531817	4048962212396	E33	1	1	5
SDS Plus II V POINTER <b>14/400/450</b>	531819	4048962212419	E33	1	1	5
SDS Plus II V POINTER <b>15/200/260</b>	531824	4048962212464	E33	1	1	5
SDS Plus II V POINTER <b>16/150/210</b>	531827	4048962212495	E33	1	1	5
SDS Plus II V POINTER <b>16/250/310</b>	531829	4048962212518	E33	1	1	5
SDS Plus II V POINTER <b>16/400/450</b>	531830	4048962212525	E33	1	1	5
SDS Plus II V POINTER <b>18/150/200</b>	531836	4048962212587	E33	1	1	5
SDS Plus II V POINTER <b>18/400/450</b>	531838	4048962212600	E33	1	1	5
SDS Plus II V POINTER <b>20/400/450</b>	531845	4048962212679	E33	1	1	5
SDS Plus II V POINTER <b>22/400/450</b>	531850	4048962212716	E33	1	1	5
SDS Plus II V POINTER <b>24/400/450</b>	531854	4048962212754	E33	1	1	5
SDS Plus II V POINTER <b>25/400/450</b>	531856	4048962212778	E33	1	1	5
SDS Plus II V POINTER <b>26/400/450</b>	531859	4048962212808	E33	1	1	5

## SDS POINTER M



Tipo	Art. nº	EAN	Familia	Unidad mínima servicio (packs)	Unidades por pack	Packs por embalaje
SDS Short POINTER M <b>6/350/410</b>	546204	4048962327526	E33	1	1	1
SDS Short POINTER M <b>8/200/260</b>	544382	4048962314045	E33	1	1	1
SDS Short POINTER M <b>10/200/260</b>	543630	4048962308716	E33	1	1	1
SDS Short POINTER M <b>12/200/260</b>	543631	4048962308723	E33	1	1	1
SDS Short POINTER M <b>14/200/260</b>	543632	4048962308730	E33	1	1	1
SDS Short POINTER M <b>16/200/260</b>	543633	4048962308747	E33	1	1	1
SDS Short POINTER M <b>16/100/400</b>	543634	4048962308754	E33	1	1	1
SDS Short POINTER M <b>18/350/410</b>	546205	4048962327533	E33	1	1	1
SDS Short POINTER M <b>20/100/400</b>	543635	4048962308761	E33	1	1	1
SDS Short POINTER M <b>22/350/410</b>	546206	4048962327540	E33	1	1	1



# Surtido

## SDS

MAX II / MAX IV



Tipo	Art. nº	EAN	Familia	Unidad mínima servicio (packs)	Unidades por pack	Packs por embalaje
SDS MAX II <b>12/400/540</b>	504189	4048962061505	E33	1	1	1
SDS MAX II <b>14/200/340</b>	504192	4048962061529	E33	1	1	1
SDS MAX II <b>14/400/540</b>	504194	4048962061536	E33	1	1	1
SDS MAX IV <b>16/200/340</b>	504198	4048962061567	E33	1	1	1
SDS MAX IV <b>16/400/540</b>	504199	4048962061574	E33	1	1	1
SDS MAX IV <b>16/800/920</b>	504200	4048962061581	E33	1	1	1
SDS MAX IV <b>16/1200/1320</b>	504206	4048962061598	E33	1	1	1
SDS MAX IV <b>18/200/340</b>	504207	4048962061604	E33	1	1	1
SDS MAX IV <b>18/400/540</b>	504208	4048962061611	E33	1	1	1
SDS MAX IV <b>20/200/320</b>	504214	4048962061642	E33	1	1	1
SDS MAX IV <b>20/400/520</b>	504217	4048962061659	E33	1	1	1
SDS MAX IV <b>20/800/920</b>	504222	4048962061666	E33	1	1	1
SDS MAX IV <b>22/200/320</b>	504224	4048962061680	E33	1	1	1
SDS MAX IV <b>22/400/520</b>	504225	4048962061697	E33	1	1	1
SDS MAX IV <b>22/800/920</b>	504226	4048962061703	E33	1	1	1
SDS MAX IV <b>24/200/320</b>	504228	4048962061727	E33	1	1	1
SDS MAX IV <b>24/400/520</b>	504229	4048962061734	E33	1	1	1
SDS MAX IV <b>25/200/320</b>	504235	4048962061741	E33	1	1	1
SDS MAX IV <b>25/400/520</b>	504236	4048962061758	E33	1	1	1
SDS MAX IV <b>25/800/920</b>	504237	4048962061765	E33	1	1	1
SDS MAX IV <b>25/1200/1320</b>	504238	4048962061772	E33	1	1	1
SDS MAX IV <b>28/250/370</b>	504240	4048962061796	E33	1	1	1
SDS MAX IV <b>28/550/670</b>	504242	4048962061819	E33	1	1	1
SDS MAX IV <b>30/250/370</b>	504245	4048962061840	E33	1	1	1
SDS MAX IV <b>32/800/920</b>	504249	4048962061888	E33	1	1	1
SDS MAX IV <b>32/1200/1320</b>	504250	4048962061895	E33	1	1	1
SDS MAX IV <b>35/450/570</b>	504256	4048962061918	E33	1	1	1
SDS MAX IV <b>35/550/670</b>	504257	4048962061925	E33	1	1	1
SDS MAX IV <b>37/450/570</b>	504265	4048962061963	E33	1	1	1
SDS MAX IV <b>40/450/570</b>	504270	4048962062014	E33	1	1	1
SDS MAX IV <b>45/450/570</b>	504274	4048962062045	E33	1	1	1
SDS MAX IV <b>52/450/570</b>	504276	4048962062069	E33	1	1	1

## SDS

FHD



Tipo	Art. nº	EAN	Familia	Unidad mínima servicio (packs)	Unidades por pack	Packs por embalaje
FHD <b>12/200/330</b>	546597	4048962330823	E33	1	1	1
FHD <b>14/250/380</b>	546598	4048962330830	E33	1	1	1
FHD <b>16/250/380</b>	546599	4048962330847	E33	1	1	1
FHD <b>18/320/450</b>	546600	4048962330854	E33	1	1	1
FHD MAX <b>16/400/620</b>	546601	4048962330861	E33	1	1	1
FHD MAX <b>18/400/620</b>	546602	4048962330878	E33	1	1	1
FHD MAX <b>20/400/621</b>	546603	4048962330885	E33	1	1	1
FHD MAX <b>24/400/621</b>	546604	4048962330892	E33	1	1	1
FHD MAX <b>28/600/820</b>	546605	4048962330908	E33	1	1	1
FHD MAX <b>30/600/820</b>	546606	4048962330915	E33	1	1	1
FHD MAX <b>35/650/870</b>	546607	4048962330922	E33	1	1	1
ASPIRADOR FVC <b>35 M</b>	551924	4048962355680	E33	1	1	1

## SDS

CINCELES FCP

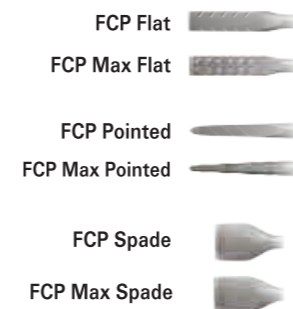

Tipo	Art. nº	EAN	Familia	Unidad mínima servicio (packs)	Unidades por pack	Packs por embalaje
FCP Flat <b>20/250</b>	546315	4048962329001	E33	1	1	1
FCP Max Flat <b>25/400</b>	546318	4048962329032	E33	1	1	1
FCP Pointed <b>250</b>	546314	4048962328998	E33	1	1	1
FCP Max Pointed <b>400</b>	546317	4048962329025	E33	1	1	1
FCP Spade <b>40/250</b>	546316	4048962329018	E33	1	1	1
FCP Max Spade <b>50/380</b>	546319	4048962329049	E33	1	1	1
FCP Set	546320	4048962329056	E33	1	1	1
FCP Max Set	546321	4048962329063	E33	1	1	1

# Surtido

## Porcelánico

### ULTIMATE



Tipo	Art. nº	EAN	Familia	Unidad mínima servicio (packs)	Unidades por pack	Packs por embalaje
ULTIMATE DRILL <b>5x85</b>	530623	4048962204292	E32	1	1	60
ULTIMATE DRILL <b>6x100</b>	530624	4048962204308	E32	1	1	60
ULTIMATE DRILL <b>8x125</b>	530626	4048962204322	E32	1	1	30

## Porcelánico

### D-GT



Tipo	Art. nº	EAN	Familia	Unidad mínima servicio (packs)	Unidades por pack	Packs por embalaje
D-GT <b>4,0x10/60</b>	551342	4042205342017	E33	1	1	1
D-GT <b>5,0x11/70</b>	551340	4042205342031	E33	1	1	1
D-GT <b>6,0x13/75</b>	551341	4042205342024	E33	1	1	1
D-GT <b>8,0x14/80</b>	551343	4042205342000	E33	1	1	1
D-GT <b>10,0x15/100</b>	551344	4042205341997	E33	1	1	1

## Porcelánico

### DIAMANTE



Tipo	Art. nº	EAN	Familia	Unidad mínima servicio (packs)	Unidades por pack	Packs por embalaje
HS-Di <b>5,0</b>	551345	4048962287035	E26	1	1	15
HS-Di <b>6,0</b>	551346	4048962287042	E26	1	1	15
HS-Di <b>8,0</b>	551347	4048962287059	E26	1	1	15
HS-Di <b>10,0</b>	551348	4048962287066	E26	1	1	15
HS-Di <b>12,0</b>	551349	4048962287073	E26	1	1	15
HS-Di <b>14,0</b>	551350	4048962287080	E26	1	1	15

## Coronas

### MULTIMATERIAL



Tipo	Art. nº	EAN	Familia	Unidad mínima servicio (packs)	Unidades por pack	Packs por embalaje
HS-Multi <b>20,0</b>	551351	4048962287097	E26	1	1	30
HS-Multi <b>25,0</b>	551353	4048962287103	E26	1	1	30
HS-Multi <b>30,0</b>	551354	4048962287110	E26	1	1	15
HS-Multi <b>35,0</b>	551358	4048962287127	E26	1	1	15
HS-Multi <b>40,0</b>	551360	4048962287134	E26	1	1	15
HS-Multi <b>51,0</b>	551361	4048962287141	E26	1	1	10
HS-Multi <b>60,0</b>	551362	4048962287158	E26	1	1	5
HS-Multi <b>68,0</b>	551363	4048962287165	E26	1	1	5
HS-Multi <b>83,0</b>	551364	4048962287172	E26	1	1	5
HS-Multi <b>89,0</b>	551365	4048962287189	E26	1	1	5
HS-Multi <b>102,0</b>	551366	4048962287196	E26	1	1	5
Adaptador HS-Multi A1S (hasta <b>Ø30</b> )	551367	4048962287202	E26	1	1	15
Adaptador HS-Multi A2S ( <b>Ø30-Ø102</b> )	551368	4048962287219	E26	1	1	10
Punta centradora (para ladrillo)	551369	4048962287226	E26	1	1	25
Punta centradora (para madera)	551370	4048962287233	E26	1	1	25
Extensor Corona <b>300mm</b>	553385	4048962365573	E26	1	1	10

## Coronas

### METAL



Tipo	Art. nº	EAN	Familia	Unidad mínima servicio (packs)	Unidades por pack	Packs por embalaje
HS-HSS-Co <b>20,0</b>	532001	4048962213836	E26	1	1	30
HS-HSS-Co <b>25,0</b>	532007	4048962213904	E26	1	1	30
HS-HSS-Co <b>30,0</b>	532012	4048962213959	E26	1	1	15
HS-HSS-Co <b>35,0</b>	532016	4048962213997	E26	1	1	15
HS-HSS-Co <b>40,0</b>	532019	4048962214024	E26	1	1	15
HS-HSS-Co <b>51,0</b>	532025	4048962214086	E26	1	1	7
HS-HSS-Co <b>60,0</b>	532032	4048962214130	E26	1	1	7
HS-HSS-Co <b>68,0</b>	532036	4048962214178	E26	1	1	7
HS-HSS-Co <b>83,0</b>	532044	4048962214246	E26	1	1	7
HS-HSS-Co <b>102,0</b>	532054	4048962214314	E26	1	1	7
Adaptador HS-HSS-Co A1 (hasta <b>Ø30</b> )	532057	4048962214345	E26	1	1	15
Adaptador HS-HSS-Co A2 ( <b>Ø30-Ø102</b> )	532058	4048962214352	E26	1	1	10
Punta centradora (para metal)	532061	4048962214369	E26	1	1	25



**fischer Ibérica, S. A.U.**

**ESPAÑA**

C. O'Donnell 12, Planta 2

28009 Madrid

Tel. 91 047 97 97

email: [servicio.cliente@fischer.es](mailto:servicio.cliente@fischer.es)

**[www.fischer.es](http://www.fischer.es)**

